

Low-Pass Filter for the 80 MHz Band

DESCRIPTION

- Medium power low-pass filter for the 66 – 88 MHz range.
- Attenuates especially 2. and 3. harmonics.
- High frequency stability on temperature and power.
- Attenuation in stop band better than 40 dB.
- Extremely low insertion loss (less than 0.2 dB).



SPECIFICATIONS

Electrical	
Model	PRO-LP 80
Frequency	Pass band : 66 - 88 MHz Stop band : 132 - 264 MHz
Max. Input Power	150 W
Pass Band Insertion Loss	< 0.2 dB (typ. < 0.1dB)
Impedance	50 Ω
Application	Low-pass filter for the 80 MHz band
VSWR	< 1.5:1
Stop Band Attenuation	> 40 dB

Mechanical	
Connection(s)	N(f) / N(m)
Dimensions	98 (incl. conn.) x 39.5 x 28 mm / 3.85 x 1.5 x 1.1 in.
Weight	Approx. 0.15 kg / 0.33 lb.
Mounting	3.2 mm dia. (4 holes)

Environmental	
Operating temperature range	-30 °C to +60 °C

ORDERING

Model	Product No.
PRO-LP 80	200001278

TYPICAL RESPONSE CURVE

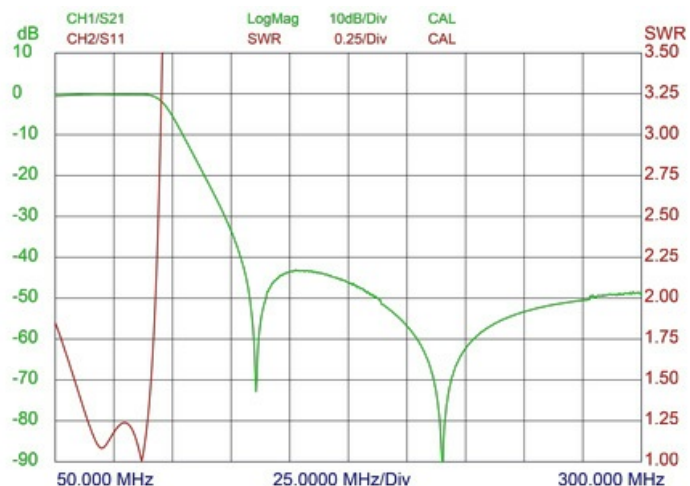

MOUNTING DETAILS

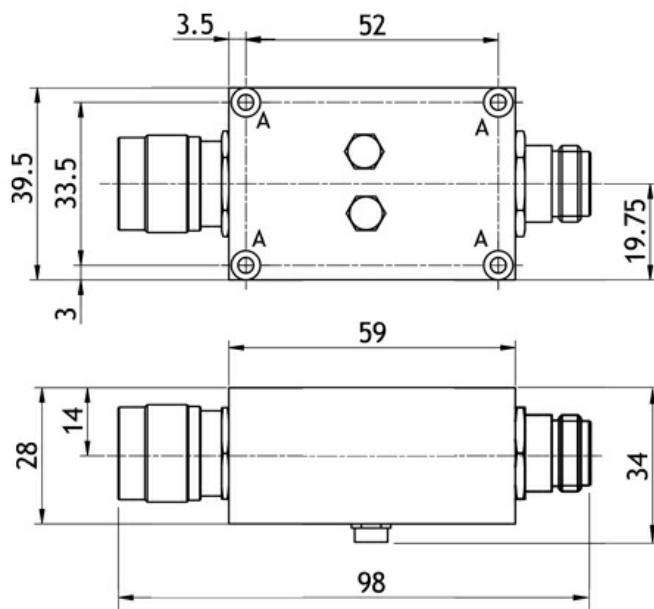

All dimensions are given in mm [in.]

